

Billing Methods Guide



Tabs3 Billing



PracticeMaster



Trust Accounting



Accounts Payable



General Ledger

Tabs3 Billing Methods Guide

Copyright © 2013-2024

Software Technology, LLC
1621 Cushman Drive
Lincoln, NE 68512
(402) 423-1440

Tabs3.com

Tabs3, PracticeMaster, Tabs3Pay, and the “pinwheel” symbol () are registered trademarks of Software Technology, LLC.

Version 2023 (Monday, January 1, 2024)

Table of Contents

Purpose of this Guide	1
Knowledge Base	1
Additional Resources	1
Tab3 Billing Cycle	2
Billing Methods Overview	3
Hourly Billing	5
Determining Rates via the Fee Rate Table	6
Determining Rates via the Timekeeper Level Method	7
Determining Rates via the Timekeeper Rates Method	10
Client’s Hourly Rate Method	12
How Tab3 Selects the Default Billing Rate	12
In Summary	14
Contingency Billing	15
Questions to Ask	15
Configuring Contingency Billing	15
Generating Statements	16
Once the Matter is Resolved	16
Flat Fee Billing	17
Questions to Ask	17
Implementing Flat Fee Billing	17
Value Billing	20
Progress Billing	22
Questions to Ask	22

Procedure	23
Reconciliation Statement When Progress Billing	24
Retainer Billing	26
Questions to Ask	26
Retainer Billing Using Tab3 Trust Accounting	26
Using Progress Billing to Handle Retainers	29
Using Client Funds to Handle Retainer Billing	30
Entering Payments to Handle Retainers	31
Comparing Different Methods of Retainer Billing	31
Retainer Billing Examples	31
Example 1: Nonrefundable Retainer	32
Example 1a: Nonrefundable Non-Replenishable Retainer	33
Example 2: Refundable Retainer	33
Example 3: Monthly Retainer Plus Fees	34
Example 4: Nonrefundable Retainer	34
Example 5: Replenishable Retainer	35
Example 6: Monthly Retainer Covers Fees	36
Example 7: Recurring Nonrefundable Retainer	36
Example 8: Nonrefundable Retainer	37
Split Billing	39
Questions to Ask	39
Configuring Split Billing	40
Task Based Billing	44
Setting Up Task Based Billing in Tab3	45
Task Code Sets	45
Tasks/Phases	46
Activities/Expenses	47
Categories	48
Clients	48
Reports Associated With Task Based Billing	49

Threshold Billing	50
Questions to Ask	51
Threshold Billing Examples	53
Courtesy Discount	53
Resources	56
Built-in Help	56
Knowledge Base	56
Tabs3 Support	57
Index	58

Purpose of this Guide

The Tabs3 Billing Methods Guide covers the various methods of billing clients that are available in Tabs3. It includes information on basic billing concepts that are important to individuals who enter client information in Tabs3 Billing.

Depending on the type of law you practice, your bills may range from a simple printed monthly statement for a single client, to a complex electronic submission split between multiple insurance companies. Tabs3 is designed to help you manage your billing process efficiently in all circumstances.

Many users are unaware of the additional billing features available in Tabs3. Data entry and billing for complex matters can be very frustrating without these additional tools. This guide will help you determine which method of billing is appropriate for each matter, and show you how to properly configure Tabs3 for that method. Once a matter is configured, you can enter work for that case normally, with any additional configuration or adjustments performed during the billing process, or when the matter is concluded.

Additional guides for separate software features are also available. All guides are available on our Web site at:

Tabs3.com/support/docs.html

Knowledge Base

You may be referred to additional detailed information located in our Knowledge Base on the Internet at:

support.Tabs3.com

Additional Resources

A comprehensive list of all resources for Tabs3 software can be found on page 56.

Tab3 Billing Cycle

Billing in Tab3 involves several steps. The following provides a general overview of the Tab3 billing cycle.

Add Fees and Costs

Data entry is performed in the Fee and Cost programs in Tab3 Billing and PracticeMaster. Timekeepers enter their work over the course of the billing cycle, specifying the date, transaction code, and hours worked for each fee, and the date, transaction code, and units for each cost. Data entry is done on an ongoing basis throughout the billing cycle.

Generate Pre-Bills

Once you are ready to start generating bills, it's time to make sure the data was entered correctly. You can use either Draft Statements or the Detail Work-in-Process Report to provide pre-bill information for your timekeepers to review for accuracy. Pre-bills are also referred to as draft statements. You can use the Pre-Bill Tracking feature in Tab3 Billing to track which pre-bills have been returned.

Review Pre-Bills

After you have generated your pre-bills, you can distribute them to the appropriate timekeepers. After the timekeepers return the approved statements, you can make any necessary edits. Once all the necessary changes have been made, you can proceed to the next phase.

Make Adjustments

Some billing methods require that transactions be adjusted prior to billing. Flat fee billing and split billing utilize the Adjust Flat Fee Clients and Perform Split Billing programs, which are designed specifically for their billing types. Other billing types require use of the Write-Up/Down program. More information on adjustments can be found in the **Billing Adjustments Guide** as well as in the individual billing method chapters of this guide. Once you have completed your adjustments, you can generate pre-bills for the adjusted clients as needed for review.

Generate Final Statements

Once all of the information on your pre-bills is correct, it's time to run final statements. Running final statements begins the process of moving the transactions included on the statement from a status of "work-in-process" to a status of "billed". This is important because payments can only be applied to billed transactions.

Update Statements

Updating statements completes the process of moving transactions from a work-in-process status to a billed status. Once a statement has been updated, you can apply payments to the billed transactions. Additionally, the Update Statements process applies any previously entered unapplied payments.

Distribute Statements

Once your statements have been updated, you can distribute them to their respective clients. Methods of distributing statements can include mailing printed statements, emailing electronic files, or submitting bills electronically via the Tab3 Taskbill software.

Training Videos

You can view the following training videos for more information. Clicking a link will open the associated training video in your browser. All training videos are also accessible in the software via the **Help | Training Videos** menu and at [Tabs3.com/video](https://www.tabs3.com/video).



[Working with Fees](#)



[Working with Costs](#)



[Statement Generation Basics](#)

Billing Methods Overview

There are several commonly used types of billing that are discussed in this guide. Below is a brief overview of each type. More information on each billing type can be found in the relevant section of this guide.

Hourly Billing	Hourly billing is the default billing method in Tabs3 Billing, and is the basis of most other billing types. Hourly billing determines the amount to bill by multiplying the billable hours and the rate (<i>page 5</i>).
Contingency Billing	Contingency billing allows you to enter time normally for matters where payment is contingent on a judgment or settlement. Once the compensation amount is determined, fees are written up or down as needed to match the amount before billing the client (<i>page 15</i>).
Flat Fee Billing	Flat Fee billing allows you to specify a flat amount each billing cycle or at the end of the work done for the matter. Fees are entered normally and then written up or down to match the flat amount before statements are generated (<i>page 17</i>).
Value Billing	Value billing allows you to charge a specific amount for a service rather than basing the amount on the time spent performing the service (<i>page 20</i>).
Progress Billing	Progress Billing can be used when you don't know what the final billing amount will be, but you still want to bill progressively toward that unknown amount (<i>page 22</i>).
Retainer Billing	Retainer billing is used for matters where the client is paying via a retainer, either all up front, partially, or on an ongoing basis. Tabs3 Billing has multiple options for tracking retainers and invoicing clients for additional retainer funds as needed (<i>page 26</i>).
Split Billing	Split Billing allows you split fees and costs between multiple matters based on specified percentages (<i>page 39</i>).
Task Based Billing	Task based billing is a method of billing that is often mandated by insurance companies and large corporations that require billing information be submitted in a uniform manner. This allows them to easily compare and analyze billing information from all firms submitting bills (<i>page 44</i>).
Threshold Billing	Threshold billing allows you to prevent clients from receiving statements when their bill is below a specified threshold (<i>page 50</i>).

Courtesy Discount

Courtesy discounts allow you to apply a fixed or percentage-based discount to a client's bill. Discounts can be one time only, or applied to every bill for the client (page 53).

Hourly Billing

Tab3 Billing tracks two hours fields for each fee transaction:

- **Hours Worked** - the number of hours worked on transactions; and
- **Hours to Bill** - the number of hours billed.

Hourly billing is based on the premise:

$$\text{Hours to Bill} \times \text{Hourly Rate} = \text{Amount to be Billed}$$

The **Hours to Bill** field defaults to the number of hours entered in the **Hours Worked** field. Tab3 Billing determines the **Hourly Rate** based on how you have set up each client and automatically calculates the **Amount to be Billed**. Therefore, when making fee entries, only the **Hours Worked** field is needed to determine the **Amount**.

Tab3 Billing is truly flexible when it comes to assigning default billing rates. You can set up your clients and never have to worry about whether you are using the correct rate for each timekeeper. Tab3 Billing does it all for you. Once you have set up your clients and are making fee entries, you may want to use a different billing rate than the default rate. Simply overwrite the default rate by entering the rate you want to use for the transaction.

There are several different methods that Tab3 Billing can use to determine the correct default billing rate:

Fee Rate Table Method	(page 6)
Timekeeper Level Method	(page 7)
Timekeeper Rates Method	(page 10)
Client's Hourly Rate Method	(page 12)

Determining Rates via the Fee Rate Table

Tabs3 Billing allows you to create a fee rate table for each client. This table consists of a list of timekeepers with one rate per timekeeper. If a timekeeper's rate changes, a new rate can be specified along with a cut-off date that indicates which transactions entered from this point forward will use the new rate. There is no limit to the number of timekeepers that can be included in the rate table. This table is created via the **Fee Rate Table** button on the **Rates** tab of the Client file.

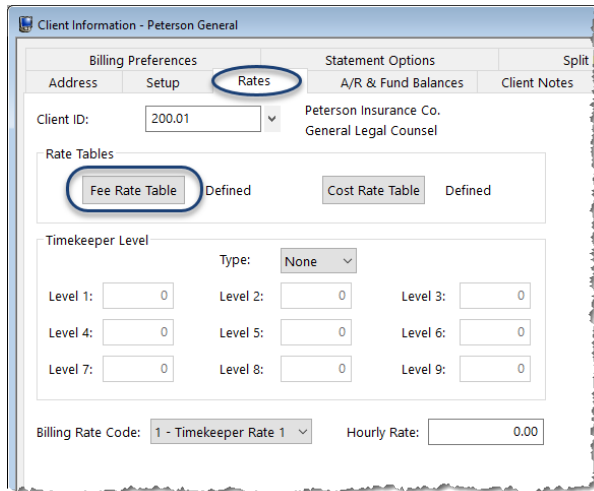

Figure 1, Rates Tab

Figure 2 is an example of the Fee Rate Table window.

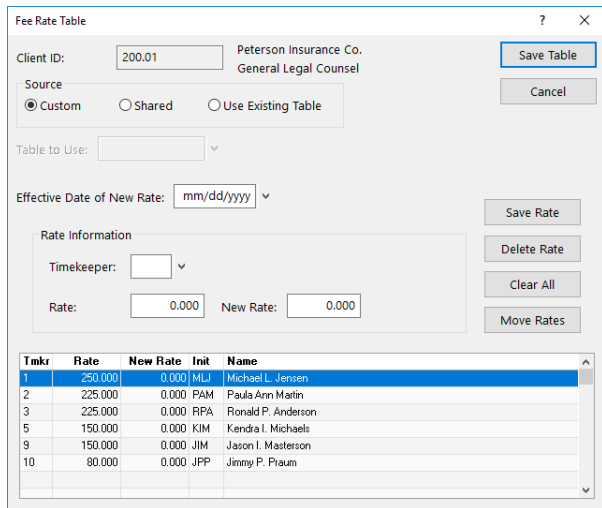

Figure 2, Fee Rate Table window

Creation of fee rate tables is entirely optional. You can add rates for any or all of the timekeepers who are working for the client. When defining a fee rate table, you can define a new table from scratch, use an existing table as a basis for a new rate table, or share an existing fee rate table. When using fee rate tables for clients with multiple matters, you can set up a separate table for each file, or you can assign a shared fee rate table. Allowing separate rate tables gives you the flexibility of

having different billing rates for each file. However, when the rates are all the same, it is easier to maintain shared fee rate tables.

When adding a fee transaction, Tab3 Billing checks to see if a fee rate table exists for the client and then checks to see if a rate has been assigned for the timekeeper. The fee rate table takes precedence over any other method of determining the default billing rate for a transaction.

Tip: Firms with multiple matters per client will often use the fee rate table method for those clients. For example, let's say you have an insurance company as a client with hundreds of matters. All work for all matters for this client use the same rate structure. In this situation, set up a fee rate table for the first matter and set up the second matter to share the first matter's rate table. All subsequent matters will default to a shared rate table using the first matter as the shared rate table. Using this structure has the added benefit of making it extremely easy to change the rate structure for the client—you simply change the rates for the first matter.

Determining Rates via the Timekeeper Level Method

Another method of selecting default billing rates is the Timekeeper Level method. The Timekeeper Level method uses the **Level** field assigned to each timekeeper in the Timekeeper file. The **Level** field is user-defined and is a number from 1 to 9. For example, senior partners may be assigned a level of "1," partners may be assigned a level of "2," associates may be assigned a level of "3," paralegals may be assigned a level of "4," etc.

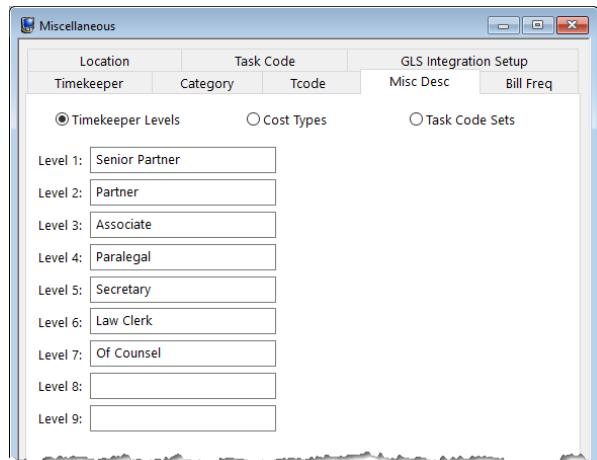

Figure 3, Timekeeper Levels window

The Timekeeper Level method is assigned on the **Rates** tab of the Client file. You have the option of assigning an hourly billing rate to each level or assigning a **Billing Rate Code** to each level (you can choose one or the other, but not both). The **Timekeeper Level Type** specified determines which method is used.

The screenshot shows the 'Client Information - Phillips/Marcus' window with the 'Rates' tab selected. The 'Timekeeper Level' section is highlighted with a blue border. It contains a 'Type' dropdown menu set to 'None'. Below this are nine input fields for levels 1 through 9, all containing the value '0'. At the bottom of the section, the 'Billing Rate Code' is set to '1 - Timekeeper Rate 1' and the 'Hourly Rate' is '0.00'.

Figure 4, Timekeeper Level section

Rate

If **Rate** is specified for the Timekeeper Level Type, you will be allowed to enter an *hourly billing rate* for each timekeeper level (1-9) as shown in the following figure.

The screenshot shows the 'Timekeeper Level' section with the 'Type' dropdown set to 'Rate'. The input fields for levels 1 through 9 contain the following values: Level 1: 275.00, Level 2: 225.00, Level 3: 150.00, Level 4: 0.00, Level 5: 0.00, Level 6: 0.00, Level 7: 0.00, Level 8: 0.00, Level 9: 0.00.

Figure 5, Assignment of Timekeeper Level Rates

This gives you the opportunity to define similar types of timekeepers as having a rate unique to each level. For example, all timekeepers with a Level of "1" will be billed out at the rate specified for Level 1. All timekeepers with a Level of "2" will be billed out at the rate specified for Level 2, etc. If a rate of \$0.00 is entered, then the **Billing Rate Code** from the Client file is used to determine the default billing rate.

Code

If **Code** is specified for the Timekeeper Level Type, you will be allowed to enter a *billing rate code (0-9)* for each timekeeper level (1-9) as shown in the following figure.

Timekeeper Level		
		Type: Code
Level 1:	<input type="text" value="2"/>	Level 2: <input type="text" value="4"/>
		Level 3: <input type="text" value="2"/>
Level 4:	<input type="text" value="3"/>	Level 5: <input type="text" value="1"/>
		Level 6: <input type="text" value="1"/>
Level 7:	<input type="text" value="1"/>	Level 8: <input type="text" value="1"/>
		Level 9: <input type="text" value="1"/>

Figure 6, Assignment of Timekeeper Level Codes

This allows you to assign a specific billing rate code to each timekeeper level.

- A code of "1" thru "6" indicates that the corresponding rate for the timekeeper from the timekeeper file should be used (i.e., code "1" refers to rate #1, code "2" refers to rate #2, etc.). For example, in the scenario shown in Figure 6, if the timekeeper is assigned to a **Timekeeper Level** of "2", then **Rate 4** from the Timekeeper file would be used. See the **Timekeeper Rates Method** section (page 10) and Figure 7 for more information on timekeeper rates.
- A code of "7," indicates that the rate will be taken from the **Rate** field assigned to the transaction code in the Transaction Code file.
- A code of "8," indicates that the rate will be calculated from the **Amount** field assigned to the transaction code in the Transaction Code file.
- A code of "9," indicates that the **Hourly Rate** field from the **Rates** tab of the Client file will be used.
- A code of "0," indicates that the **Billing Rate Code** from the **Rates** tab of the Client file will be used to determine the default billing rate.

Determining Rates via the Timekeeper Rates Method

This method of determining a default billing rate is used if the timekeeper does not have a rate assigned in a fee rate table and the Timekeeper Level **Type** option on the **Rates** tab of the Client file is set to **None**.

The screenshot shows the 'Timekeeper Rates' window. At the top, there are tabs for 'Location', 'Task Code', and 'GLS Integration Setup'. Below these are fields for 'Timekeeper' (set to 3), 'Name' (Ronald P. Anderson), 'Initials' (RPA), and 'Level' (2 - Partner). There is an 'Inactive' checkbox and a 'Profitability' button. The 'Rates' section contains a table with two columns: 'Hourly Rate' and 'New Rate'. The 'Effective Date of New Rates' is set to 'mm/dd/yyyy'. A 'Move Rates' button is at the bottom.

Hourly Rate	New Rate
160.00	0.00
190.00	0.00
115.00	0.00
105.00	0.00
145.00	0.00
0.00	0.00

Figure 7, Timekeeper Data Entry Window

Tabs3 Billing allows you to set up six different billing rates for each timekeeper when using the Timekeeper file. If a timekeeper's rate changes, a new rate can be specified along with a cut-off date that indicates which transactions entered from this point forward will use the new rate.

Billing rates can be assigned any way you want, but it is best to have some method for the assignment of rates. We recommend that the definition of each hourly rate be consistent for all timekeepers (i.e., standard rate, premium rate, discounted rate, etc.).

In Figure 7, **Hourly Rate 1** is the rate that is used for the standard billing rate for all timekeepers. **Hourly Rate 2** is a premium rate for all timekeepers. **Hourly Rate 3** is a discounted rate for all timekeepers.

Once the timekeeper rates have been configured, you can then determine the rates each matter will use in the Client file. When setting up a new client record, you will assign a **Billing Rate Code** on the **Rates** tab of the Client file.

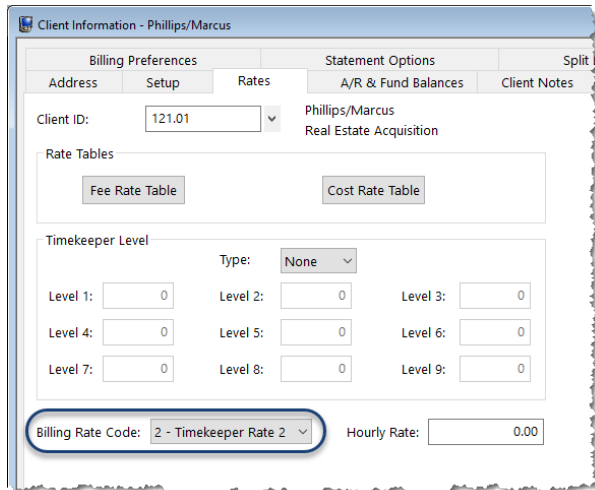

Figure 8, Billing Rate Code

The **Billing Rate Code** is used for determining the default billing rate.

- A **Billing Rate Code** of “1” through “6” corresponds to one of the timekeeper’s six **Hourly Billing Rate** fields defined in the timekeeper file. In Figure 7, Timekeeper #3’s billing rate #1 is \$210.00 per hour, billing rate #2 is \$240.00 per hour, and billing rate #3 is \$160.00 per hour.

Example: If you assign a **Billing Rate Code** of 3 to a client, all fee entries will use **Hourly Rate 3** for each timekeeper by default. If you make a fee entry for timekeeper #3, the Hourly Billing Rate #3 of \$165.00 will be used. (Note: The **Billing Rate Code** is overridden by the **Timekeeper Level** and **Fee Rate Table** settings. See the **How Tab3 Selects the Default Billing Rate** section on page 12 for more information.)

- A **Billing Rate Code** of “0” indicates the client is a flat fee client and rate #1 from the timekeeper file is used by default. See the **Flat Fee Billing** section on page 17 for more information on the Flat Fee billing method.
- A **Billing Rate Code** of “7” indicates the rate will be pulled from the Transaction Code file.
- A **Billing Rate Code** of “8” indicates the rate will be calculated from the Amount assigned in the Transaction Code file.

Client's Hourly Rate Method

A **Billing Rate Code** of "9" on the **Rates** tab of the Client file indicates the **Hourly Rate** from the Client file will be used as the default rate. You can use this method when you want the same rate used by all timekeepers.

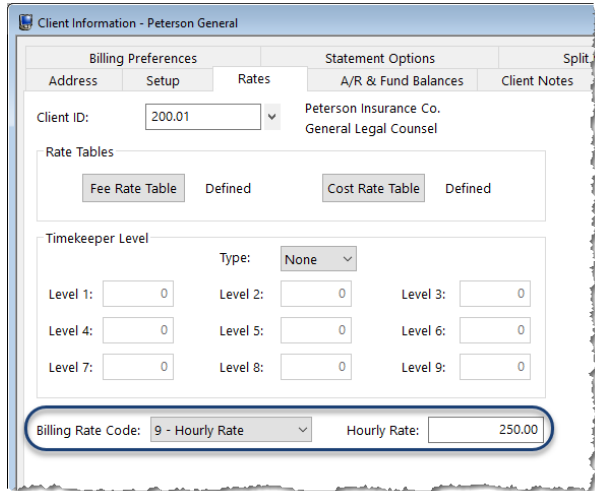

Figure 9, Hourly Rate Setting

How Tab3 Selects the Default Billing Rate

Each fee transaction has a **Rate Code** field. The **Rate Code** determines the default billing rate. The default **Rate Code** for new fee transactions is normally "0".

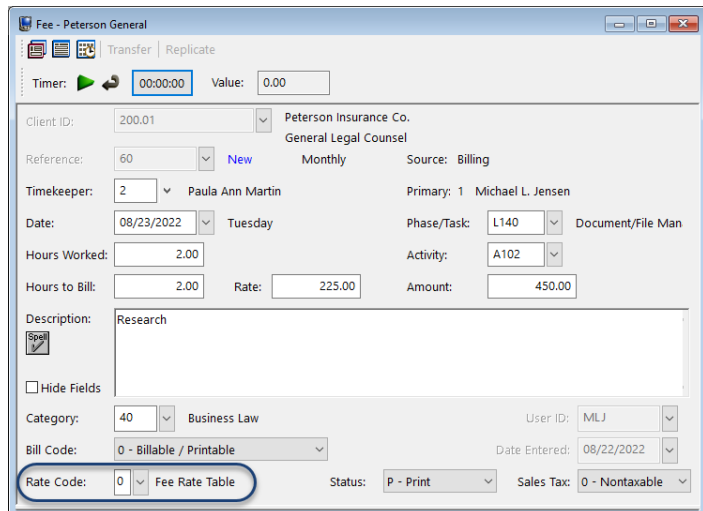

Figure 10, Fee Entry window

Rate Code of "0" - When a fee transaction is entered with a **Rate Code** of "0," the following steps are used by Tab3 to determine the default billing rate:

1. Is there a fee rate table for the client? If so, does the timekeeper that was entered for the fee transaction have a rate assigned in the fee rate table? If a rate is found in the fee rate table for the timekeeper, then that rate is used. If a rate is not found, then Tab3 Billing goes to step 2.
2. What is entered for the Timekeeper Level Type field on the **Rates** tab of the Client file?
 - If the **Timekeeper Level Type** field is set to "Rate", then the assigned rate for that timekeeper's level is used. If a rate of "0.00" is entered, then the **Billing Rate Code** from the Client file is used to determine the default billing rate (as explained in step 3).
 - If the **Timekeeper Level Type** field is set to "Code", then the assigned rate code for that timekeeper's level is used. A code of "1" thru "6" indicates that the corresponding rate for the timekeeper from the timekeeper file will be used (i.e., code "1" refers to rate #1, code "2" refers to rate #2, etc.). If the code is "7," then the rate will be taken from the transaction code file. If the code is "8," then the rate will be calculated from the amount assigned in the transaction code file. If the code is "9," then the rate from the **Hourly Rate** field in the Client file will be used. If the code is "0," then the **Billing Rate Code** from the Client file will be used to determine the default billing rate (as explained in step 3).
 - If the **Timekeeper Level Type** field is set to **None**, then Tab3 Billing goes to step 3.
3. If a default billing rate is not established in step 1 or 2, then Tab3 Billing checks the client's **Billing Rate Code** assigned on the **Rates** tab of the Client file. If the client's **Billing Rate Code** is "0," then this indicates a flat fee client and the default rate #1 from the timekeeper file is used. If the client's **Billing Rate Code** is "1 thru 6," then the corresponding rate from the timekeeper file will be used. If the client's **Billing Rate Code** is "7," then the rate will be taken from the **Rate** field in the transaction code file. If the client's **Billing Rate Code** is "8," then the rate will be calculated from the amount assigned in the transaction code file. If the client's **Billing Rate Code** is "9," then the rate from the Client file's **Hourly Rate** field will be used.

Rate Code of "1 thru 6" - When a fee transaction is entered with a **Rate Code** of "1 thru 6," the corresponding rate from the timekeeper file will be used.

Rate Code of "7" - When a fee transaction is entered with a **Rate Code** of "7," the rate will be taken from the transaction code file.

Rate Code of "8" - When a fee transaction is entered with a **Rate Code** of "8," the rate will be calculated from the amount assigned in the transaction code file.

Rate Code of "9" - When a fee transaction is entered with a **Rate Code** of "9," the rate from the **Hourly Rate** field in the Client file will be used.

Tip: When using a *fee* transaction code in the Fee data entry program, the **Rate Code** will default to zero even if a rate or amount has been specified for the transaction code. If you want to use the default rate or amount from the transaction code file, you must manually change the **Rate Code** field.

When performing value billing, you normally want a fee transaction to default to a predefined amount. Because of this, if you have certain fee transactions that should always use a specific rate or amount, you may want to consider setting them up as cost transaction codes. If you use a cost transaction code in the Fee data entry program (as opposed to a *fee* transaction code), the **Rate Code** will default to "7" if a rate has been specified in the transaction code file or "8" if an amount has been specified in the transaction code file. (See also **Value Billing** on page 20.)

In Summary

Remember, you can always overwrite the default billing rate when you are entering a fee transaction. This is done by entering a **Rate Code** other than "0" in the Fee data entry program *or* by entering the desired rate in place of the default **Rate** displayed on the screen.

We recommend using the Timekeeper Rates method (*page 10*) whenever possible. This method is the easiest to maintain and requires no additional data entry when adding clients.

Keep in mind that you can set up clients using any one of the methods available and still achieve your goal of having Tab3 Billing use the correct default billing rate for each client. You don't necessarily have to understand how each method works. The point is to be able to select a method that works for you and your clients. Many of these methods were designed to cater to "exceptions" to the rule. Each client can use a different method. The fee rate tables are probably the easiest to understand and use, and are also the most flexible. However, additional data entry (setting up the fee rate table) is required for each client.

Training Videos

You can view the following training video for more information. Clicking the link will open the training video in your browser. All training videos are also accessible in the software via the **Help | Training Videos** menu and at [Tabs3.com/video](https://www.tabs3.com/video).



[How Rates Work](#)



[Effective Date of New Rates](#)

Contingency Billing

Contingency billing occurs when a firm performs work for a client and gets paid contingent upon a settlement. There are many variations for this type of arrangement, such as whether or not costs will be billed, percentage amounts of the settlement, etc. When billing contingency clients, you typically bill them after the matter is settled; however, you may also want to bill them during the course of the matter. When billing during the course of the matter, you may want to bill only expenses or advances. You may also want the client to see the services rendered for a particular time frame without actually billing the fees. Tab3 Billing allows you to do all of this.

Questions to Ask

Are costs being billed during the course of the matter?

While fees may be billed on a contingency basis, expenses and advances typically continue to be billed on an ongoing basis during the course of the matter. You may want to bill costs on a regular cycle, bill them once they hit a specific threshold, or save them until the end of the matter.

Should fees be included on statements even if they are not being billed?

Sometimes the client may want or need to review the ongoing work being done. You can configure a statement template with an **Info Only** fee format for clients who want to see their ongoing fees or a **No Fees** fee format for clients who don't want to see fees, as shown in the following section (*Figure 11*).

Configuring Contingency Billing

When billing a contingency client, you can use a statement template with an **Info Only** fee format. This will show the fee information on the statement but will not bill the fees. Instead, the fee transactions remain as work-in-process until completion of the matter. If desired, you can print a statement for a specified date range of fee transactions. The Update Statements program does not update the fee transactions to accounts receivable until a final statement is run using a statement template with a **Standard** fee format.

If you do not want any fees to be shown on the statement, then use a statement template with a fee format of **No Fees**.

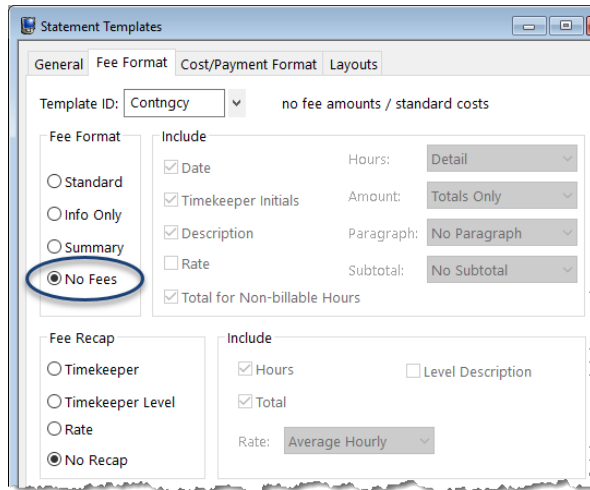

Figure 11, **Fee Format** tab, Statement Templates window

More Info: Information on configuring statement templates can be found in Tab3 Billing Help and the **Tab3 Statement Formatting Guide**.

Generating Statements

When generating statements for contingency matters, if you are including fees on the statements, you will typically want to specify a date range for fees to prevent the fees from the previous billing cycle from appearing.

Once the Matter is Resolved

Once the matter is complete and the final amount that the firm is receiving has been determined, it's time to bill the client for that amount.

1. Use the Write-Up/Write-Down Fees and Costs program (**Statements | Statement Preparation | Write Up/Write Down Fees and Costs**) to adjust the total fees to match the settlement amount. (*More Info: See the **Billing Adjustments Guide** for more information on using Write-Up/Write-Down Fees and Costs.*)
2. Change the matter's statement template to one that uses a fee format of **Standard**.
3. Generate the statement with no date range specified.

Training Videos

You can view the following training video for more information. Clicking the link will open the training video in your browser. All training videos are also accessible in the software via the **Help | Training Videos** menu and at [Tabs3.com/video](https://www.tabs3.com/video).



Flat Fee Billing

Flat fee billing occurs when a matter is billed a predefined amount regardless of the amount of work performed. Tabs3 Billing's flat fee billing feature allows you to bill a flat fee amount when all the work is completed or periodically bill a flat fee amount. While fees are billed as a flat amount, costs are billed normally.

Questions to Ask

Are you billing a flat fee amount every billing period or a single flat fee amount at the conclusion of the matter?

If you are billing a single flat fee amount, do you want the unbilled fees to appear on statements when costs are billed?

The answers to the above questions will help you configure your flat fee clients.

Implementing Flat Fee Billing

Implementing flat fee billing for a matter consists of setting the clients Billing Rate Code to "0", specifying a Flat Amount, and assigning an appropriate statement template. Once those steps are done, you can enter your fees normally and run the Adjust Flat Fee Billing program as needed before generating statements.

► To implement flat fee billing

1. From the Quick Launch, search for and select "Client Information."
2. Select the matter you want to configure for flat fee billing in the **Client ID** field.
3. Click the **Rates** tab.

The screenshot shows the 'Billing Preferences' tab with the following details:

- Client ID:** 101.00
- Client Name:** Williams/John, State v. Williams
- Rate Tables:** Fee Rate Table, Cost Rate Table
- Timekeeper Level:** Type: None; Levels 1-9 are all set to 0.
- Billing Rate Code:** 0 - Flat Fee Amount
- Flat Amount:** 900.00

Figure 12, Flat Fee Amount Configuration

3. Select **0 - Flat Fee Amount** in the **Billing Rate Code** field. This indicates that this matter is a flat fee matter.
4. Upon specifying the **Billing Rate Code**, the **Hourly Rate** field is changed to a **Flat Amount** field. Enter the flat fee amount in the **Flat Amount** field.
5. Click the **Statement Options** tab to select a statement template for the matter in the **Draft Template** and **Final Template** fields.

The screenshot shows the 'Statement Options' tab with the following details:

- Client ID:** 101.00
- Client Name:** Williams/John, State v. Williams
- Statement Format:** Draft Template: Draft, Final Template: Hours
- Trust Integration:** Summary
- Cover Statement:** Detail
- Combine Matters:**
- Main Cover Client:**

Figure 13, Statement Options tab

6. You can view a template's settings by right clicking the template name and selecting **Edit Statement Templates**.
 - If you will be billing costs periodically for the matter and do not want fees to be billed, select a statement template that uses a fee format of **No Fees** so that fees are not billed.

- If you want the client to see the services rendered for a particular time frame during the course of the work without actually billing the fees, you can use a statement template with a fee format of **Info Only**.
- If you will be billing a flat fee amount on a regular basis, select a statement template that uses a fee format of **Standard** in order to “release” the fee entries for billing.

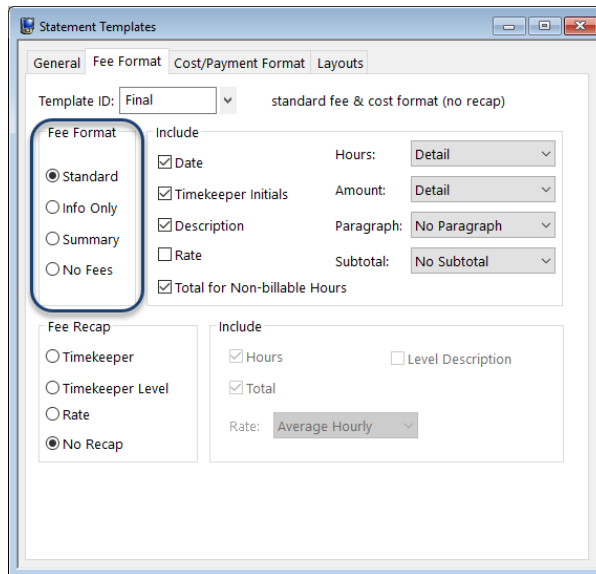

Figure 14, Statement Template window

7. Enter all time charges as you normally would for an hourly billed matter.
8. When you are ready to bill the matter, select a statement template for the matter that uses a fee format of **Standard** in order to “release” the fee entries for billing. (Note: No change is required if the client has already been assigned a statement template that uses a fee format of **Standard**.)
9. Use the Adjust Flat Fee Clients program (**Statements | Statement Preparation | Adjust Flat Fee Clients**) to adjust the fee entries to the client’s preset flat amount. If desired, you can specify a range of dates, timekeepers, transaction codes, and categories to indicate which fee entries you want adjusted.

More Info: See the Flat Fee Billing section of the *Billing Adjustments Guide* for information on using the Adjust Flat Fee Clients program.

10. Run the Generate Statements program.

Training Videos

You can view the following training video for more information. Clicking the link will open the training video in your browser. All training videos are also accessible in the software via the **Help | Training Videos** menu and at Tabs3.com/video.



Value Billing

Value Billing is defined as a fee charged for the value received by the client without regard to the time spent by the timekeeper. Value Billing is very easy to do in Tabs3 Billing. Typically, Value Billing is performed for a single transaction. With the advent of technology, it is now possible to prepare many standard documents in a fraction of the time it previously took. For example, even though it may take less than 20 minutes to prepare a will or a tax return for a client, the value of what you have provided for the client is worth more than the 20 minutes it took to prepare the documents using your document assembly software or tax preparation software.

The screenshot shows the 'Miscellaneous' window for setting up a transaction code. The fields are as follows:

Location	Task Code	GLS Integration Setup		
Timekeeper	Category	Tcode	Misc Desc	Bill Freq
Tcode:	273	New	Alpha Code:	
Type:	0 - Normal		Transaction Type:	Expense
Cost Type:	0 - Miscellaneous			
Description:	Document preparation			
Bill Code:	0 - Billable / Printable		Charge Sales Tax:	<input type="checkbox"/>
Amount:	300.00		Effective Date of New Rate:	mm/dd/yyyy
Rate:	0.000		New Rate:	0.000

Buttons: Spell, Move Rate

Figure 15, Transaction Code Setup for Value Billing

Set up the transaction codes you want to value bill as Expense or Advance transaction codes in the Transaction Code program. Enter the desired amount in the transaction code's **Amount** field. (When expense or advance transaction codes are entered as fees, Tab3 Billing uses the transaction code's **Amount** field for the fee **Amount** rather than the **Hours x Rate** formula.)

The screenshot shows a software window titled "Fee - Gilbert/Andrew C." with a menu bar containing "Transfer" and "Replicate". Below the menu bar is a "Timer" section with a play button, a "00:00:00" display, and a "Value: 0.00" field. The main form area contains the following fields and values:

- Client ID: 102.00 (dropdown)
- Reference: 17 (dropdown), New (button), Monthly (text), Source: Billing (text)
- Timekeeper: 1 (dropdown), Michael L. Jensen (text), Primary: 2 Paula Ann Martin (text)
- Date: 08/23/2022 (dropdown), Tuesday (text), Tcode: 273 (dropdown), Normal (text)
- Hours Worked: 0.75 (text)
- Hours to Bill: 0.75 (text), Rate: 400.00 (text), Amount: 300.00 (text)
- Description: Document preparation (text area)
- Category: 65 (dropdown), Personal Injury (text)
- Bill Code: 0 - Billable / Printable (dropdown)
- Rate Code: 8 (dropdown), Tcode Amount (text)
- Status: P - Print (dropdown), Sales Tax: 0 - Nontaxable (dropdown)

Figure 16, Fee entry using Value Billing

When you want to use this transaction code for value billing, select the expense/advance transaction code in the fee data entry program. After selecting the transaction code, the **Rate Code** field will automatically default to "8," which tells Tab3 Billing to retrieve the amount from the transaction code file. Enter the number of hours that you want the timekeeper to be given credit for on the productivity reports. After you have entered the hours, press Enter to move to the next field. Tab3 Billing will automatically calculate the rate based on the hours to bill and amount entered.

Note: When using Value Billing, the adjustments are not tracked as a write-up or write-down on the productivity reports. This is because Rate x Hours = Amount to be Billed and there is no write-up or write-down. However, if **Hours Worked** differs from **Hours to Bill**, then an Hour Write-Up or Hour Write-Down will be shown as well as a Write-Up Hours Value or Write-Down Hours Value.

Note: When the client's Billing Rate Code is "8," Tab3 Billing will automatically enter the amount from the transaction code file in the **Amount** field.

Progress Billing

Progress billing can be used when you don't know what the final billing amount will be but you still want to bill progressively toward that unknown amount. You can bill a fixed amount on a regular basis or only once; or you can bill a different amount for each billing. Progress billing can also be used when you know the final billing amount and want to bill the client up front, but you don't know the number of hours it will take. The latter situation applies to certain types of flat fee billing, value billing and retainer billing.

In a nutshell, progress billing allows you to bill a client amounts that are unrelated to the actual time being spent working for the client. The amounts are maintained in a separate area in Tabs3 Billing, yet are also updated to accounts receivable. Once the work is finished (i.e., the final amount has been established and/or all timeslips have been added), a "reconciliation" statement is processed that applies the amounts billed toward the actual finished work.

One of the main differences between progress billing and other billing is that with progress billing, timekeepers do not receive credit for billed productivity until the account is reconciled. When multiple timekeepers work on a single file, it may be desirable not to give timekeepers credit for billed productivity until the file is complete so that any write-up or write-down can be distributed on a prorated basis.

Questions to Ask

Are you billing progressively, or all up front?

If you are billing progressively, how much do you want to bill each time?

The answers to these questions will help you configure matters for progress billing.

Procedure

To set up a Progress Billing client, select the **Progress Billing** check box on the **Billing Preferences** tab of the Client file.

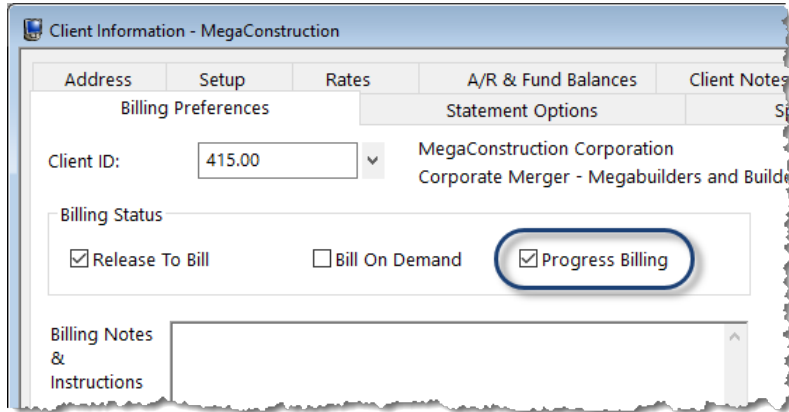

Figure 17, Progress Billing Option in Client file

To bill a progressive amount toward current or future work-in-process, add a fee transaction using a Type 6 transaction code (Progress Billing). The Type 6 fee transaction will not allow you to enter anything in the **Rate** or **Hours** fields, only an **Amount**. Enter the amount you want to bill at this time. Run a final statement for the client and update the statement. The only fee that will be billed on the statement is the Type 6 fee transaction. If desired, you can bill multiple Type 6 transactions on the same statement. The Accounts Receivable Reports will show a balance due for the Type 6 amount you just billed (provided a payment was not included on the statement). You have the option of charging sales tax on Type 6 transaction codes.



Figure 18, Type 6 Transaction in Fee program

When the Type 6 transaction is updated, the billed productivity figures are not updated. However, many of the reports will show amounts for billed Type 6 transactions and/or paid Type 6 transactions. These reports include the Detail and Summary Work-In-Process Reports, the Aged Work-In-Process Report, the Detail and Summary Accounts Receivable Reports, the Accounts Receivable by Invoice Report, the Collections Report, the Client Productivity Report, the Client Ledger Report, the Receipt Allocation Report, the Allocated Payments Report, the Unallocated Payments Report, the Timekeeper Status Report, the Client Realization Report, and the Client Budget Report. Also, the Transaction File List subtotals the Type 6 transactions as a separate line item. **Tab3 Billing Sample Reports** describes where progress billed amounts are shown on the various reports.

As work proceeds on the file, enter fee and cost transactions as you would for a normal hourly client. When you are ready to bill another progressive amount, enter a Type 6 transaction, run a final statement and update the statement.

As payments are entered, they are allocated to these statements and their associated progress fees. During the reconciliation process, the payments will be reallocated to the previously unbilled transactions based on the matter's Method to Apply Payments settings.

Tab3 allows you to select **Save** in the **Status** field when entering a Type 6 transaction. This allows the Type 6 transaction to be billed and saved for successive progressive billings. This is especially helpful if you are billing the same amount for each progressive billing. If you are changing the amount, you can edit the Type 6 transaction if it was entered with the Save option, or you can enter a new Type 6 fee transaction.

If you want to bill only the Type 6 transaction and not show other fee transactions, use a statement template with a fee format of **Standard**. Since the **Progress Billing** check box is selected, the Type 6 transaction(s) will be the only transaction(s) "released" for billing.

If you want to also include other fee transactions on the statement, you can use a fee format of **Info Only**. This format lets you to print and bill the Type 6 fee transactions as well as print regular fee transactions without billing them. This allows you to bill the progressive amount but still show the client the descriptions and hours of services rendered.

The regular fee transactions remain in work-in-process until a reconciliation statement is run for the client and is updated.

Reconciliation Statement When Progress Billing

After all work has been completed on a file, you are ready to "reconcile" the client's account. In order to reconcile the client's account:

1. Clear the **Progress Billing** check box on the **Billing Preferences** tab of the Client file.
2. If you are using a statement template with a fee format of **Info Only**, you will want to change the statement template to one with a fee format of **Standard**.
3. Review work-in-process by printing a Detail Work-In-Process Report or a draft statement.
4. After reviewing the work-in-process, you may want to write-up or write-down fees before billing.
5. After making any necessary adjustments, run a final statement. The final statement will reflect any unpaid progress billings in the previous balance and will also reflect all progress billings in the line item "Adjustment For Prior Billings" as a credit amount. The regular fee transactions will be printed according to the statement template you have selected and will be totaled and printed on the For Current Services Rendered line. *(Note: If desired, you have the ability to change the terminology of the "Adjustment for Prior Billings" line on line 24 of the **Terminology** tab in Statement Customization.)*

- After printing the reconciliation statement, run the Update Statements program. After updating the statement, the accounts receivable and productivity information will be updated.

The following is an example of a reconciliation statement:

Fees	

Telephone conference with client. Letter to client's trustee. Telephone conference with client's trustee. Office conference with client.	
For Current Services Rendered	465.00
Adjustment for Prior Billings	-400.00
Balance Due	\$65.00 =====

Figure 19, Example of a Reconciliation Statement for a Progress Billing Client

Note: You will not be able to change the **Progress Billing** check box if the Update Statements program has not been run since a final statement was processed for the client. After running the Update Statements program, you will be allowed to change the check box.

Note: When printing a reconciliation statement, if the **Statement Type** for the client's statement template is set to **Invoice Format** and Tab3 Billing is configured to exclude credits on invoice format statements (on the **Options** tab of Statement Customization), then the "Adjustment For Prior Billings" line will not be printed on the statement. Either change the client's **Statement Type** to **Statement Format** or change Statement Customization to allow credits to print on invoice format statements.

GLS Integration Note: When a payment is applied to Progress Fees, journal entries will be created for the payments based on the accounts defined in GLS Integration Setup for posting payments allocated to Progress Fees (or the Unapplied Payments account, if no Progress Fees accounts are defined). When "reconciling" the client's account, the payment will be allocated. Adjusting journal entries will be created to transfer the amount of the allocated payment from the Progress Fees (or Unallocated Payments) accounts to the designated payment allocation accounts configured in GLS Integration Setup.

Retainer Billing

There are various types of retainer billing and accordingly various methods of handling retainer billing.

Using Trust for Refundable Retainer Billing

Tab3 Trust Accounting (Trust) can be used to handle retainers—particularly refundable retainers.

Using Progress Billing to Handle Retainers

The Progress Billing feature can be used to handle retainers for some situations.

Using Tab3 Client Funds to Handle Retainers

Tab3 Billing allows you to bill for retainers and keeps track of retainer activity. This feature is designed to be used for nonrefundable retainers.

Entering Payments to Handle Retainers

You can simply enter retainers as payments for clients if you do not want to send a bill for the retainer.

Questions to Ask

Do you have Tab3 Trust Accounting (Trust) installed?

Will there be a single retainer received from the client, or will the client need to continue to fund the retainer balance?

Do you want to be able to bill the clients for additional retainer funds?

Will the retainer be applied to fees and costs?

The answers to these questions can help you determine which method of retainer billing is right for you and your client.

Retainer Billing Using Tab3 Trust Accounting

Tab3 Trust Accounting (Trust) maintains detailed accounting of trust funds, escrow funds and retainers. Trust maintains detailed activity by bank account and trust account. The trust account balance (i.e., retainer) can be included on Tab3 Billing statements as well as detailed trust account activity. Tab3 Billing also allows you to automatically bill clients for a trust account retainer. You can include a message on the Tab3 Billing statement requesting that the client remit funds (i.e., retainer) to replenish the trust account when the trust account balance is below a minimum balance. A fixed amount can be specified; or, if a target balance is specified, the difference needed to reach

the target balance will be shown in the message. Trust account balances are included on the Tabs3 Billing Detail and Summary Work-in-Process Reports.

Retainer funds maintained in Trust are typically not realized as income for the firm until the client is billed and the firm transfers funds from the retainer account to the client's accounts receivable balance in Tabs3 Billing. Therefore, even though you can show trust account retainer activity on a statement and bill retainers on the statement, the retainer funds remain in a separate Trust trust account until the funds are transferred. When a check or electronic funds transfer to the firm is entered in Trust for the client, Trust will automatically create and post a payment transaction for the client in Tabs3 Billing.

Trust includes several features that are not available with Tabs3 Billing's built-in client funds feature. Trust includes check writing capabilities, the ability to track 1099 amounts, print 1099 forms, a Check # field for each check transaction, comprehensive reporting, and a Bank Account Reconciliation program. The following is an example of a statement with detailed trust accounting activity on it. This example also includes a message to replenish the trust account balance:

Fees		

08/05/2022	Office conference with client regarding ownership of patent.	262.50
08/08/2022	Gathering of supporting documents and research regarding patent ownership.	552.50

	For Current Services Rendered	815.00
Payments		

08/12/2022	Payment transferred from trust account.	-815.00
	Balance Due	\$0.00
		=====
Trust Account Activity		
	Opening Balance	\$0.00
08/05/2022	Initial Deposit	3,000.00
08/12/2022	Legal Fees	
	PAYEE: Burns & Jensen, P.C.	-815.00

	Closing Balance	\$2,185.00
	Please remit \$815.00	
Per our initial meeting, you have agreed to maintain a balance of \$3,000 in your trust account.		

Figure 20, Example of billing a retainer using the optional integration with Tab3 Trust Accounting.

Using Progress Billing to Handle Retainers

The Progress Billing feature (*page 22*) can be used to handle retainers. This method allows you to bill the client for a retainer and works particularly well in situations where the client's fees will not be billed until the matter is settled.

Note: Progress Fee retainers can only be applied to fees—they cannot be applied to expenses or advances. If the client's retainer is used for expenses or advances, you cannot use this method for handling retainers.

The Progress Billing feature has several advantages over simply entering a payment for a retainer received. First, the Progress Billing feature can be used to bill the client for the retainer. To bill a client for a retainer, select the **Progress Billing** check box on the **Billing Preferences** tab of the Client file (*Figure 21*). Then, enter a Type 6 (progress fee) transaction for the client for the amount of the retainer. Select a statement template for the client that uses a fee format of **Info Only**. The statement will reflect the retainer transaction as well as any other fees that may have been entered; however, only the Type 6 transaction will be billed. When this statement is updated, the accounts receivable balance for the client will reflect the retainer amount due.

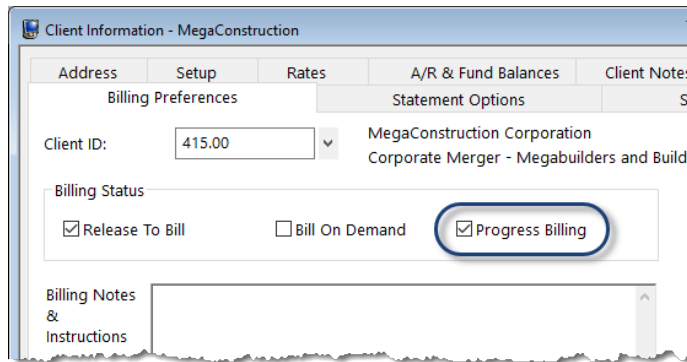

Figure 21, **Billing Preferences** tab

When the client pays the retainer, the accounts receivable balance is reduced to zero. This feature offers another advantage over simply entering payments for retainers received. When entering payments for retainers received, a negative accounts receivable balance for the client may result which may or may not be a desirable situation. By using the progress billing feature to handle retainers, you can prevent a client from having a negative accounts receivable balance.

Before fees can be billed, the client's **Progress Billing** check box must be cleared and a statement template must be selected that has a fee format of **Standard** or **Summary**. When the next statement for the client is run, the progress fee retainer balance will be reconciled on that statement.

Using Client Funds to Handle Retainer Billing

The client funds feature is used by most firms to bill and track retainer activity. Client funds accounts are set up on the **A/R & Fund Balances** tab of the Client file. Client funds account transactions are entered using the Client Funds program. The types of client funds account transactions include deposits, withdrawals, and automatic payments to the firm.

More Info: Complete details regarding client funds can be found in the Tabs3 Billing Help under "Client Funds Overview."

The client funds feature can also be used to bill the client for retainers if desired. Built-in flexibility lets you bill to replenish a pre-established minimum balance or bill a one-time retainer until it has been paid.

Client funds information can optionally be printed on statements. When included, the Client Funds section prints at the end of the client statement. All terminology used on the statement is customizable. The client's billing statement can include detailed or summarized client funds information. The following is an example of a **detail** client funds section on a statement:

Retainer Activity		
	Beginning Retainer Balance	\$1,000.00
08/08/2022	Retainer Received	2,000.00
08/19/2022	Funds transferred to account	-500.00

	Ending Retainer Balance	\$2,500.00

Figure 22, Example of a Detail Client Funds Section of a Statement

The following is an example of a **summary** client funds section on a statement.

Retainer Activity	
Client Funds Balance	\$2,500.00

Figure 23, Example of Summary Client Funds Section of a Statement

Client funds balances are tracked separately from accounts receivable balances. The following reports include client funds information.

Transaction File List Manual and automatic client funds payments.

Task Code Billing Report Manual and automatic client funds payments.

Detail Work-In-Process Report	Client funds balances.
Summary Work-In-Process Report	Client funds balances.
Detail Collections Report	Client funds balances.
Client Funds Report	Detail client funds activity.

Entering Payments to Handle Retainers

If you do not need to bill a client for a retainer, you can handle retainers by simply entering payments for the client when they are received. This method works fine for tracking a client's accounts receivable balance but does not track whether the client has paid the retainer or how much of a retainer has been requested. If no fees or costs are billed (or due) when the payment is processed, the client will have a credit balance.

Comparing Different Methods of Retainer Billing

The following table shows some of the features and considerations pertaining to the different types of retainer billing. The table indicates which methods of handling retainer billing will accommodate the specific feature.

	Trust	Progress Billing	Client Funds	Payments
Bill for a retainer on the billing statement	✓	✓	✓	
Check writing	✓			
Print 1099 forms	✓			
Check reconciliation	✓			
Check # maintained	✓			
Negative accounts receivable				✓
Separate fee, expense, and advance retainers	✓		✓	✓
Allow payments to either a third-party or Tabs3 Billing account	✓		✓	
Retainers shown in A/R	✓	✓		✓
Refundable retainer	✓			
Nonrefundable retainer	✓	✓	✓	

Retainer Billing Examples

There are many “themes and variations” of retainer billing. The following examples represent the more common types of retainer billing scenarios along with possible ways to handle the situations.

Example 1: Nonrefundable Retainer

An attorney agrees to represent a client in a criminal defense matter and requires a \$10,000 nonrefundable, non-replenishable retainer for fees and costs. If fees and costs exceed \$10,000, the attorney will bill the client for additional fees and costs. The client writes a check for the full retainer amount on his first visit.

Trust

When the \$10,000 payment is received, enter a deposit in Trust. As work proceeds, you will need to manually add check or EFT transactions in Trust and select the **This is a payment to our firm** check box to transfer funds to the Tab3 Billing account. By doing this, the Tab3 Billing statement balance will always show a zero balance until the trust balance is depleted. Trust account retainer activity will be shown at the end of the statement (detail, summary or none). Once the matter is closed, if any funds are left over, cut a check with the **This is a payment to our firm** check box selected for the amount remaining in the trust account. Then, in Tab3 Billing, enter a fee (or cost) transaction for the remaining amount. Run a final statement for the client and update it.

Tab3 Billing Client Funds

Set up the client with a \$10,000 Fund Balance by entering a \$10,000 client funds deposit. In the Client Funds section of the **A/R & Fund Balances** tab, leave both the **Minimum Balance** and **Target Balance** fields at \$0.00 and leave the **One Time Retainer** check box cleared. If the **Fund Application** option is set to Automatic All, Tab3 Billing will automatically generate payments from the Client Funds account to pay current fees and costs when a statement is generated. Client Funds activity can be shown at the end of the statement (detail, summary or none). Once the matter is closed, if any funds are left over, enter a fee (or cost) transaction for the remaining amount. Run a final statement for the client and update it.

Example 1a: Nonrefundable Non-Replenishable Retainer

This example is identical to Example 1 except the client does not pay the retainer up front. You want to bill the client for the retainer.

Trust

The retainer can be billed on a statement by entering \$10,000 in the Trust trust account record's **Desired Minimum Balance** field and the **Target Balance** (or **Amount to Bill**) fields. After billing the retainer, edit the **Target Balance** (or **Amount to Bill**) field to \$0.00 so another retainer is not billed the next time you run a statement.

Tabs3 Billing Client Funds

Select the **One Time Retainer** check box on the **A/R & Fund Balances** tab of the Client file. Set up the client with a **Retainer Amount** of \$10,000 and an **Amount to Bill** of \$10,000. Specify a **Statement Format** of Summary. The client's statement will then reflect \$10,000 due for the retainer. When the retainer amount is paid, enter a deposit using the Client Funds program. This will automatically reduce the **Amount to Bill** by the amount of the deposit. The client's next statement will reflect the amount paid as well as any remaining retainer amount due.

Example 2: Refundable Retainer

A timekeeper agrees to represent a client and requires a \$10,000 refundable retainer for fees. Any funds left over once the matter is closed will be refunded to the client.

Trust

Same as Example 1, except once the matter is closed, if any funds are left over, simply write a check to the client.

Tabs3 Billing Progress Billing

Select the **Progress Billing** check box on the **Billing Preferences** tab of the Client file. Enter the retainer using a Type 6 (progress fee) transaction. Bill and update the client. Clear the **Progress Billing** check box. Enter the payment. Enter fees and costs as required. Run a statement when required. The previous balance will be \$10,000. Let's say fees are \$12,000. A line showing "Adjustment for Prior Billings" will show -\$10,000. The payment of \$10,000 and a Balance Due of \$2,000 will print on the statement. If fees were only \$9,000, then a credit balance of \$1,000 would print on the statement. Use the Payment Adjustment program to refund the credit balance. Then, write a check to the client.

More Info: More information on Payment Adjustments can be found in the Payment Adjustments section of the ***Billing Adjustments Guide***.

Tab3 Billing Client Funds

Same as Example 1, except once the matter is closed, if any client funds are left over, enter a Withdrawal transaction in the Client Funds program equal to the remaining amount of client funds. Write a check to the client for this amount.

More Info: Complete details regarding client funds can be found in the Tab3 Help under "Client Funds Overview."

Example 3: Monthly Retainer Plus Fees

A client agrees to pay the firm \$2,000 a month for a retainer. Any legal fees incurred during the month will be billed in addition to the monthly retainer.

Tab3

This example does not require the use of client funds transactions. Enter a recurring Type 0 (normal) or Type 5 (miscellaneous) transaction in the amount of \$2,000 to bill the monthly retainer. Recurring transactions are entered by specifying Save in the **Status** field of the transaction. Enter fees and costs normally as they occur. Run statements.

Example 4: Nonrefundable Retainer

An attorney agrees to represent a client in a divorce and requires a one-time nonrefundable \$1,000 retainer to be applied toward fees and costs. Fees and costs will be billed as they are incurred. Fees and costs beyond the retainer amount will be due upon receipt of an invoice.

Trust

Same as Example 1 (except the retainer is \$1,000 instead of \$10,000).

Tabs3 Billing Progress Billing

Select the Progress Billing check box on the **Billing Preferences** tab of the Client file. Enter the retainer using a Type 6 (progress fee) transaction. Bill and update the client. Clear the **Progress Billing** check box. Enter the payment. Enter fees and costs as required. Run a statement when required. The previous balance will be \$1,000. An Adjustment for Prior Billings of -\$1,000 will print on the statement. The payment of \$1,000 will print on the statement. If the fees are \$1,250, then the balance due will be \$250. If the fees are less than \$1,000, use the Write-Up/Write-Down program to write-up the fees to \$1,000.00.

Tabs3 Billing Client Funds

Same as Example 1 (except the retainer is \$1,000 instead of \$10,000).

Example 5: Replenishable Retainer

A client agrees to maintain a \$3,000 retainer balance. Fees and costs are to be paid out of the retainer. The client will replenish the retainer balance when billed.

Trust

Enter \$3,000 in the trust account's **Target Balance** and **Desired Minimum Balance** fields. Enter fees and costs in Tabs3 Billing as they are incurred. Transfer funds as required to the client's account and run a Tabs3 Billing statement. A balance of \$0.00 will appear on the statement (provided fees and costs billed for the period do not exceed \$3,000). The Tabs3 Billing statement will show "Please remit \$_____" following the detail or summary trust activity. The amount will be the amount required to replenish the \$3,000 target balance. *(Tip: If you only want the client to replenish the retainer account when it goes below, say \$1,000, you could enter \$1,000 in the trust account's **Desired Minimum Balance** field instead of \$3,000.)*

Tab3 Billing Client Funds

On the **A/R & Fund Balances** tab of the Client file, enter \$3,000 in the **Minimum Balance** field and set the **Fund Application** to Automatic All. Enter fees and costs in Tab3 Billing as they are incurred. When a statement is generated, a payment from client funds will automatically be generated to pay fees and costs. A balance of \$0.00 will appear on the statement (provided fees and costs billed for the period do not exceed \$3,000). The Tab3 Billing statement will show "Please remit to Replenish Client Funds Balance" and the amount shown will be the amount required to replenish the \$3,000 balance. *(Tip: If you only want the client to replenish the retainer account when it goes below, say \$1,000, you could enter \$1,000 in the **Minimum Balance** field and enter \$3,000 in the **Target Balance** field.)*

Example 6: Monthly Retainer Covers Fees

A client agrees to pay the firm \$2,000 a month on retainer. Any fees incurred during the month will be paid from the retainer. Any retainer left over will be held in escrow for future legal fees.

Trust

Enter \$2,000 in the trust account's **Amount to Bill** field. Enter an amount greater than \$2,000 in the trust account's **Desired Minimum Balance** field. If an amount is not entered in the **Desired Minimum Balance**, no retainer will be billed. Therefore, if you want to ensure that \$2,000 is billed each month for a year, you should enter an amount as large as \$24,000. Bill the client monthly. Following the detail/summary Trust activity on the statement, the message "Please remit \$2,000" will be printed. When the client pays the \$2,000, enter a \$2,000 deposit in Trust. Transfer funds as required to the client's account in Tab3.

Example 7: Recurring Nonrefundable Retainer

A client agrees to pay the firm \$2,000 a month on retainer. Any fees incurred during the month will be paid from the retainer. Any retainer left over will be considered as income for the law firm to keep. Any fees over and above \$2,000 will be billed.

This example requires you to decide how you want the excess retainer applied and also requires monthly adjustments. For example, if the client's fees for the month are \$500, which timekeeper, category and transaction code should receive credit for the \$1,500 billed productivity? You could write up the \$500 to \$2000, which would prorate the excess amongst the timekeepers billing the

\$500. Or, you may want to enter a separate fee transaction for the \$1,500 to specific timekeepers, categories, and transaction codes.

Trust

Enter \$2,000 in the trust account's **Amount to Bill** field and the **Desired Minimum Balance** field. If an amount is not entered in the **Desired Minimum Balance**, no retainer will be billed. Bill the client monthly. Following the detail/summary Trust activity on the statement, the message "Please remit \$2,000" will be printed. When the client pays the \$2,000, enter a \$2,000 deposit in Trust. Transfer \$2,000 each month to the client's account in Tabs3 Billing.

Example 8: Nonrefundable Retainer

An attorney agrees to take a personal injury matter on a contingency basis. The client pays all expenses regardless of the outcome. The attorney requires a \$5,000 nonrefundable retainer in advance for expenses. As funds are depleted (depending on the status of the matter), the attorney will: 1) front additional costs on behalf of the client; 2) ask the client to pay an additional retainer; or 3) bill the client on a monthly basis.

Trust

When the retainer is received, enter a corresponding deposit in Trust. Since funds will be transferred to Tabs3 Billing for expenses as required, Tabs3 Billing statements will always show a zero balance until the trust is depleted. When entering a check or EFT (with the **This is a payment to our firm** check box selected) in Trust for the expense portion of the statement, make sure you specify a Tabs3 Billing expense payment transaction code (i.e., Type 3 and Trans. Type of Expense). Trust account retainer activity will be shown at the end of the statement (detail or summary).

Note: If desired, the retainer can be billed on a statement by entering \$5,000 in the Trust trust account record's **Desired Minimum Balance** field and the **Amount to Bill** fields. After billing the retainer, edit the **Amount to Bill** field to \$0.00 so that another retainer is not billed the next time you run a statement.

Tab3 Billing Client Funds

Select the **One Time Retainer** check box on the **A/R & Fund Balances** tab of the Client file. Set up the client with a **Retainer Amount** of \$5,000 and an **Amount to Bill** of \$5,000. Specify a **Statement Format** of Summary and select a **Fund Application** of Automatic Cost Pymt or Automatic Exp Pymt. The client's statement will then reflect \$5,000 due for the retainer. When the retainer amount is paid, enter a deposit using the Client Funds program. If only a portion of the retainer is paid, the client's next statement will reflect the amount paid as well as the remaining retainer amount due.

The client should be assigned a statement template with a **Fee Format** of Info Only (i.e., fees will not be billed but may be printed on statements). Bill the client as required. Statements will reflect expenses due and an automatic payment from client funds equal to the expenses due. Once the retainer is depleted, the firm can: 1) bill another expense retainer; 2) bill the client's expenses on an ongoing basis; or, 3) continue to pay the expenses and bill the client but add ending statement notes indicating that the amount due should not be paid and that the statement is for informational purposes and will be paid out of the settlement amount. In the third situation, the billed expenses will continue to accrue and age in accounts receivable. *(Tip: To avoid overstated accounts receivable figures once the retainer is depleted, if desired, the firm can run draft statements instead of final statements for this client until settlement time.)*

Training Videos

You can view the following training videos for more information. Clicking a link will open the associated training video in your browser. All training videos are also accessible in the software via the **Help | Training Videos** menu and at [Tabs3.com/video](https://www.tabs3.com/video).



[Working with Client Funds](#)



[Working with Payments](#)

Split Billing

Sometimes multiple entities will share responsibility for payment for a particular matter. Split Billing allows you to split the fees and costs for a single matter among multiple matters in Tab3 Billing. When you determine that charges should be split for a particular matter, you can then select which matters should receive a portion. Once you have configured split billing for a client, you enter fees and costs normally. Prior to running statements, the Perform Split Billing program is run, splitting the transactions among the specified matters per your settings.

Questions to Ask

Which matter's transactions are to be split?

The matter whose transactions are split is known as the Main Client. The **Split Billing** tab of the Main Client's record in the Client program is where all of the configuration for Split Billing will occur.

Which matters will be receiving a portion of the Main Client's transactions?

These matters are known as Split Matters, and are configured on the Main Client's **Split Billing** tab.

Is the Main Client also a Split Matter?

If the Main Client will be billed a portion of the transactions, the Main Client must also be configured as a Split Matter.

What percentage of each transaction type will each Split Matter receive?

Separate percentages can be specified for fees, expenses, and advances. You can also designate one matter to receive the remainder of each transaction type.

Do you want to split the hours and amounts directly, or do you want to split hours and units and then calculate the amounts for each matter based on their individual rates?

Some split matters may require a different rate for their portion of fees and/or costs.

Do you want to split non-billable, zero amount, and credit transactions?

Non-billable and zero amount transactions can be displayed on all Split Matters' statements or just the Main Client. Similarly, any credits applied to the Main Client can be split among the Split Matters.

Configuring Split Billing

Let's start with the main client.

► **To configure the main client**

1. From the Quick Launch, search for and select "Client Information."
2. On the **Split Billing** tab, in the **Client ID** field, select the client you want to designate as the main client.

Client ID: 101.00 Williams/John
State v. Williams

Client ID	Client Name	Work Description	Fee %	Exp %	Adv %
101.00	Williams/John	State v. Williams	REM	REM	REM
200.01	Peterson Insurance Co.	General Legal Counsel	50.0000	50.0000	50.0000

Total %: 100.0000 100.0000 100.0000

Buttons: Add, Edit, Delete

Split Fee Options:
 Split both Hours and Amount
 Split Hours and then calculate Amount
 Split Fee Credits
 Split Non-Billable and Zero Amount Fees

Split Cost Options:
 Split both Units and Amount
 Split Units and then calculate Amount
 Split Cost Credits
 Split Non-Billable and Zero Amount Costs

Figure 24, Split Billing tab

Now let's configure the options that apply to all of the split matters in the **Split Fee Options** section:

Split Fee Options

Split both Hours and Amount

Split Hours and then calculate Amount

Split Fee Credits

Split Non-Billable and Zero Amount Fees

Figure 25, Split Fee Options

1. Do you want to split both the hours and the amount of fees between split matters or do you want to split the hours and recalculate the amounts based on each split matter's assigned

rates?

- a. If you want to split both the hours and the amount for fees, select the **Split both Hours and Amount**.
 - b. If you want to recalculate the amounts for each split matter, select the **Split Hours and then calculate Amount** option.
2. If you want to split fee credits between the split matters, select the **Split Fee Credits** check box.
 3. If you want fees that are non-billable or have an amount of \$0.00 to be split between the split matters, select the **Split Non-Billable and Zero Amount Fees** check box.

Now let's configure the options that apply to all of the split matters in the **Split Cost Options** section:

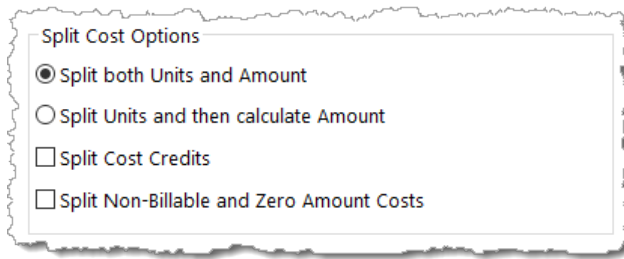

Figure 26, Split Cost Options

1. Do you want to split both the units and the amount of costs between split matters or do you want to split the units and recalculate the amounts based on each split matter's assigned rates?
 - a. If you want to split both the units and the amount for costs, select the **Split both Hours and Amount** option.
 - b. If you want to recalculate the amounts for each split matter, select the **Split Hours and then calculate Amount** option.
2. If you want to split cost credits between the split matters, select the **Split Cost Credits** check box.
3. If you want non-billable and zero amount costs to be split between the split matters, select the **Split Non-Billable and Zero Amount Costs** check box.

► **To configure Split Matters**

1. From the Quick Launch, search for and select "Client Information."
2. On the **Split Billing** tab, in the **Client ID** field, select the client you want to designate as the main client.
3. Click the **Add** button to open the Split Billing Matter window.

Figure 27, Split Billing Matter Window

4. If the main client is also a split matter, select the main client in the **Split Matter ID** field. Otherwise select the first split matter.
5. Specify the **Fees %**, **Expenses %**, and **Advances %** this matter will receive.
6. Select the **Remainder** check boxes if you want this matter to receive the remainder if the total of all of the split matters does not equal 100%.
7. If you want the matter to see the original transaction amounts on their statements, select the **Show pre-split values on statements** check box.
8. If you want to show a summary of all split billing charges on the matter's statements, select the **Show Split Billing Summary on statements** check box.
 - a. Select the **Detail** option to show a breakdown of fees, expenses, and advances in the Split Billing Summary.
 - b. Select the **Summary** option to show only the total for each split matter in the Split Billing Summary.
9. Repeat steps 3-8 until you have configured all of the split matters for this client.

► **Entering fees and costs**

Once you have completed these steps, you can save the main client record and enter fees and costs for the main client normally.

► **Generating Statements**

Prior to generating statements for the main client and split matters, you must run the Perform Split Billing program. This program removes the original transactions from the main client, and creates new split transactions for all of the split matters according to the specified settings.

More Info: See the Perform Split Billing section of the ***Billing Adjustments Guide*** for information on using the Perform Split Billing program.

► **Reversing a Split**

If you need to reverse a split that has already been made, you can use the Undo Split Billing program to reverse any split for which all the transactions are still in Work In Process.

More Info: See the Perform Split Billing section of the ***Billing Adjustments Guide*** for information on using the Undo Split Billing program.

Training Videos

You can view the following training video for more information. Clicking the link will open the training video in your browser. All training videos are also accessible in the software via the **Help | Training Videos** menu and at [Tabs3.com/video](https://www.tabs3.com/video).



Task Based Billing

Task based billing is an alternative method of hourly billing that is often mandated by insurance companies and large corporations. These companies require billing information to be submitted in a uniform manner. This allows them to easily compare and analyze billing information from all firms submitting bills. The Uniform Task-Based Management System was used to implement task based billing in Tab3.

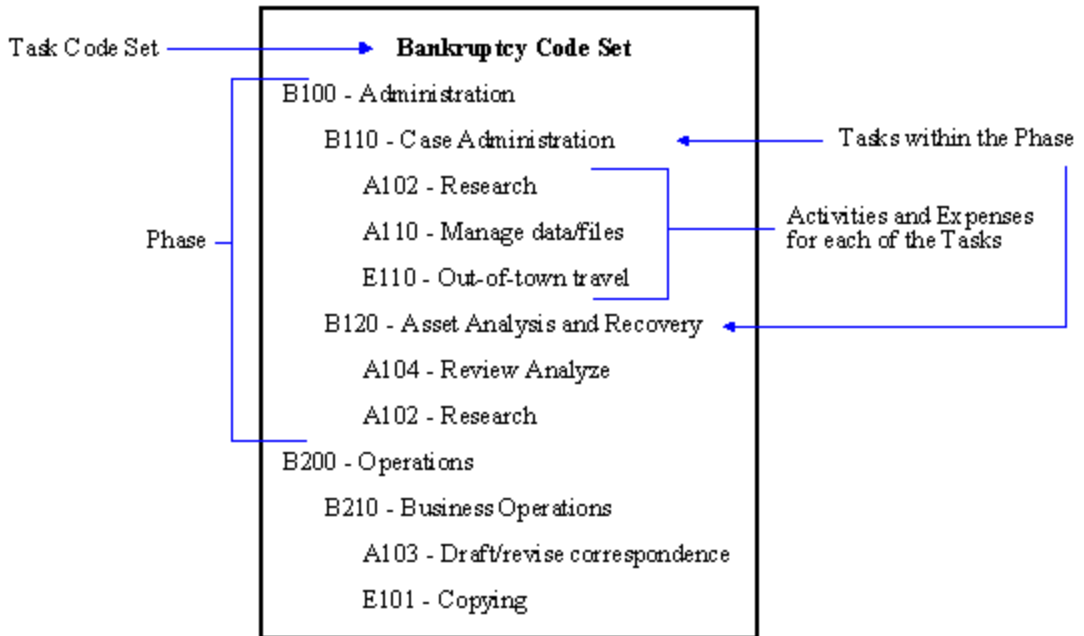

Figure 28, Task Code Set with Phases, Tasks, Activities and Expenses

Task based billing uses a three-tier hierarchy. At the top is a **task code set**. Each task code set corresponds to a general type of work such as Bankruptcy or Non-Litigation Counseling.

Within each task code set, there are **phases** that occur throughout the duration of a matter. For example, in a bankruptcy matter, there might be a phase for administration and a phase for operations. Within each phase, there may be **tasks** which represent more detail for the particular phase. Tasks are generally associated with tangible work accomplished. Examples of tasks within the administration phase of a bankruptcy matter include “case administration,” “asset analysis and recovery” and “asset disposition.” Each phase or task is assigned a four- or five-character code comprised of the task code set one- or two-letter combination followed by a three-digit number. Budget amounts can optionally be specified for each task or phase.

Finally, for each task there are **activities** that are performed and **expenses** that are incurred. Activities generally describe how work within a phase or task is accomplished. Examples of activities include “plan and prepare,” “research” and “draft/revise.” Expenses are costs for the phase such as “copying” and “court fees.” Activities and expenses are common for all task code sets. In other words, the activities used for the Bankruptcy task code set are the same as the activities for the Non-Litigation Counseling task code set. Like phases and tasks, each activity is assigned a four-character code. For activities, this code consists of the letter “A” (Activity) followed by a three-digit number. For expenses, this code consists of the letters “E” or “X” (EXpense) followed by a three-digit number.

During data entry for task based billing clients, you must specify a task or phase code as well as an activity or expense code. Once data entry is complete, the task based billing information is saved to a disk file (using the Task Code Billing Report in Tabs3 Billing) and provided to the client. The client can then track the amount of time spent and expenses incurred on each activity within each task.

It is important to remember that if your firm is performing work for a company that requires task based billing information, the individual task code sets, phases, tasks and activities will be provided to you. The **Tabs3 Report Pack** includes examples of task code sets, phase/task codes, activity codes and expense codes suggested by the Uniform Task-Based Management System. If starter data was included when Tabs3 was installed, task code sets may have already been installed.

Setting Up Task Based Billing in Tabs3

There are several files that must be set up before you can begin to perform data entry using the task based billing features in Tabs3. The following includes each file, gives a brief description and indicates where the information is set up in Tabs3.

Task Code Sets

Menu: [File](#) | [Open](#) | [Miscellaneous](#) | [Misc Desc](#) | [Task Code Sets](#)
Home: [All Actions](#) | [Setup](#) | [Task Code Set Descriptions](#)
Quick Launch: [Task Code Set Descriptions](#)

Each of the task code sets that will be used must be set up using the Task Code Sets option. Each task code set is assigned a one or two letter combination (AA-ZZ excluding the letters “A” and “E”).

► To define Task Code Sets

1. From the Tabs3 Billing Task Folders, click the **Setup** tab, and then click the **Task Code Sets** icon.

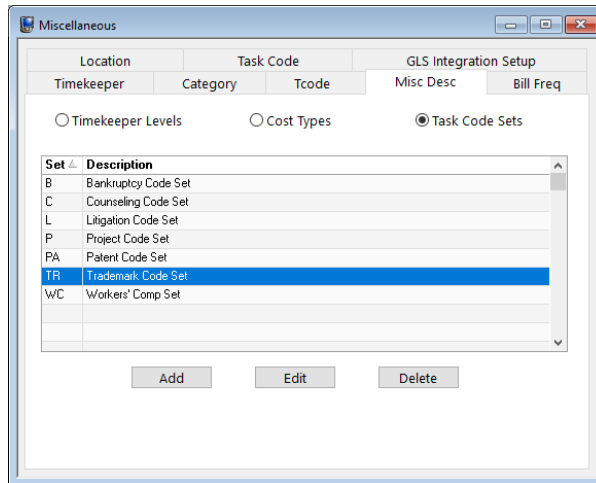

Figure 29, Task Code Sets window

2. If the task code set you need is not listed, click the **Add** button to open the Edit Task Code Set Description window (Figure 30).

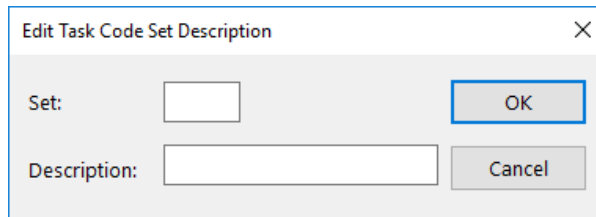

Figure 30, Edit Task Code Set Description window

3. In the **Set** field, specify the code you want to assign to the new task code set.
4. In the **Description** field, enter the a description for the new set.

Tasks/Phases

Menu: *File | Open | Miscellaneous | Task Code*
Home: *All Actions | Setup | Task Code Information*
Quick Launch: *Task Code Information*

Once the task code sets have been set up, define the tasks and phases for each of the task code sets.

► To define Tasks and Phases

1. From the **File** menu, select **Open**, and then click **Miscellaneous**.
2. Click the **Task Codes** tab.

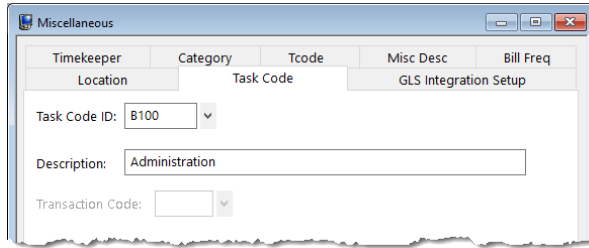

Figure 31, Task Code window

2. In the **Task Code ID** field, specify the code you want to assign to the new task or phase.
3. In the **Description** field, enter the a description for the new task or phase.

Activities/Expenses

Menu: *File | Open | Miscellaneous | Task Code*

Home: *All Actions | Setup | Task Code Information*

Quick Launch: *Task Code Information*

Set up the Activity and Expense codes that will be used for task based billing. The Activity and Expense codes are defined using the same program used to define tasks and phases.

► To define Activity and Expense Codes

1. From the **File** menu, select **Open**, and then click **Miscellaneous**.
2. Click the **Task Codes** tab.

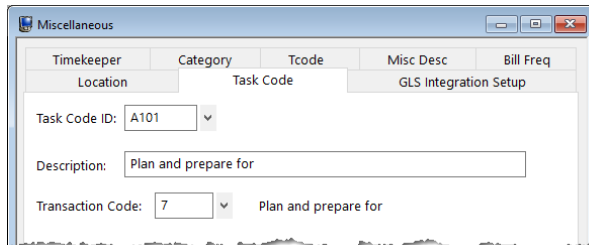

Figure 32, Task Code window

3. In the **Task Code ID** field, specify the code you want to assign to the new activity or expense.
4. In the **Description** field, enter the a description for the new activity or expense.
5. In the **Transaction Code** field, select the transaction code that you want to associate with this activity or expense.

Categories

- Menu:** [File](#) | [Open](#) | [Miscellaneous](#) | [Category](#)
Home: [All Actions](#) | [Setup](#) | [Category Information](#)
Quick Launch: [Category Information](#)

Each Tab3 Billing category can optionally be associated with a specific task code set. When a task code set is assigned to a category, only tasks from that task code set can be selected when performing data entry for a client assigned to that category. If the category assigned to a client is not assigned to a task code set, then tasks from any task code set can be selected during data entry. Using categories with your task based clients helps ensure that only valid codes are submitted, reducing the possibility that the insurance company will reject the bill.

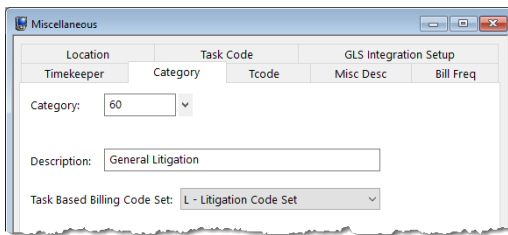

Figure 33, **Category** tab

Clients

- Menu:** [File](#) | [Data Entry](#) | [Client](#)
Home: [All Actions](#) | [People](#) | [Client Information](#)
Quick Launch: [Client Information](#)

For each client that will be billed using the task based method of billing, select the **Task Based Billing Client** check box on the **Setup** tab of the Client file.

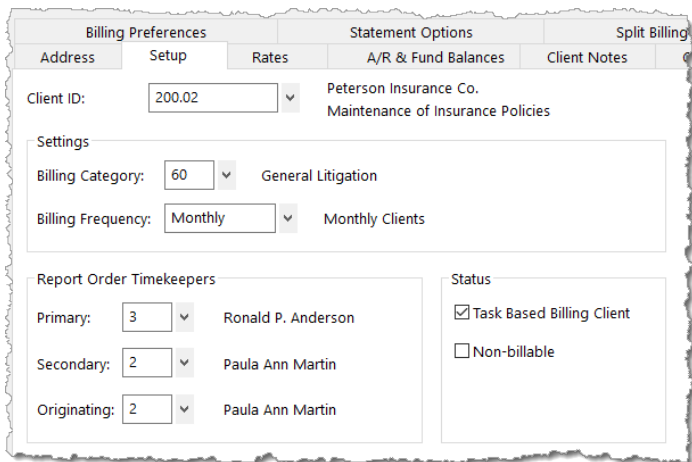

Figure 34, Client file **Setup** tab

You can also click the Task Based Billing Budget button on the **Budget** tab and enter activity and expense budget amounts for each task or phase. This budget information is used on the Task Code Budget Report. When implemented, a message will be displayed during data entry if the total fees or costs entered exceed the budget for a phase or task.

Reports Associated With Task Based Billing

There are several reports in Tabs3 Billing that are specific to the task based billing features in the software.

Task Code Billing Report	Prints a list of fee, cost and/or payment transactions that are in work-in-process or the archive files.
Task Code Budget Report	Shows budgeted activity and expense amounts for each task in each phase.
Task Code List	Shows the defined task codes and their associated descriptions.
Task Code Set List	Shows the task code sets that have been configured in Tabs3 and their associated descriptions.

Other reports such as the Detail Work-In-Process Report and Transaction File List are not specific to task based billing but can include transactions from task based billing clients.

When running most reports, task based billing clients can easily be included or excluded from the report as shown in Figure 35.

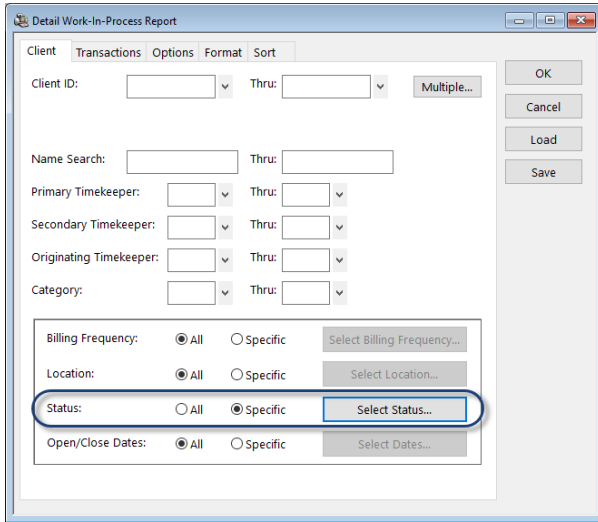

Figure 35, Selecting Task Based Billing Clients for Reports

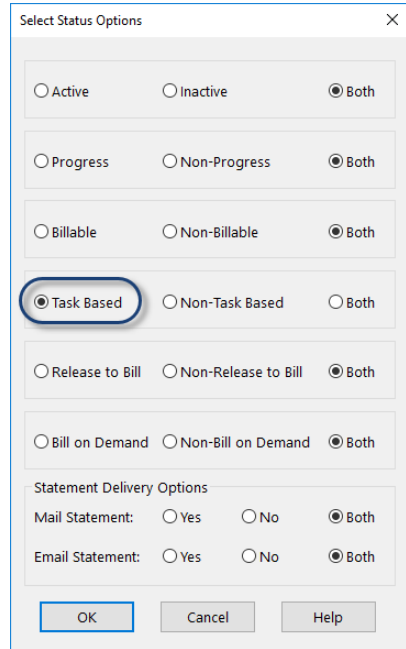

Figure 36, Selecting Task Based Billing Clients for Reports

Training Videos

You can view the following training video for more information. Clicking the link will open the training video in your browser. All training videos are also accessible in the software via the **Help | Training Videos** menu and at Tabs3.com/video.



Threshold Billing

Threshold billing prevents work-in-process from being billed unless the work-in-process totals meet a specified amount. Threshold billing can be implemented at both the client level and the statement level. Specifying thresholds at the client level allows different thresholds to be used for each client. Thresholds specified at the client level take precedence over thresholds specified when statements are run.

Questions to Ask

Do you want to apply thresholds to all clients or specific clients?

Do you want to set thresholds for each transaction type (fee, expense, advance), or do you want a total threshold for all transactions?

Answering these questions will help you determine which threshold billing settings are appropriate for you.

► Configuring Threshold Billing

Tabs3 Billing allows you to specify separate work-in-process thresholds for fees, expenses and advances or a total threshold for the client on the **Billing Options** tab (Figure 37).

Address	Setup	Rates	A/R & Fund Balances	Client Notes
Billing Options		Billing Preferences		Statement Options
Client ID:	121.01	Phillips/Marcus Real Estate Acquisition		
Threshold Billing Items				
<input checked="" type="radio"/>	Bill individual item if its threshold is met	Fee:	50.00	
<input type="radio"/>	Bill all items if any threshold is met	Exp:	25.00	
<input type="radio"/>	Bill all items if Total threshold is met	Adv:	25.00	

Figure 37, **Billing Options** tab of Client file

You can also specify billing thresholds for all clients included with a statement batch by clicking the **Threshold Billing** button on the **Options** tab of the Generate Statements window (Figure 38). This threshold setting only applies to the current statement batch and does not apply to clients who are already configured for threshold billing.

Generate Statements

Client Transactions Options Sort

Statement Type
 Draft
 Print Reference Numbers
 Update Pre-Bill Tracking
 Print Billing Notes & Instructions
 Final
 Use Original Statement Number

Print
 Zero Balance Payment Only Clients
 Task Based Billing Information
 Cover Statement Only
 Statement Run Totals
 Criteria Page

Output Options
 Number of Copies: 1
 PDFs as Individual Statements
 (Using DropBox or Print to File/PDF)

Statement Options
 Statement Date: 08/23/2022
 Beginning Statement Number: 7631
 Last Numbers Used: 7630 thru 7630
 Statement Template
 Email Template

Criteria
 Print Reminder Statement for Clients
 Detail
 Summary
 With no Statement Since: mm/dd/yyyy
 Include Clients:
 with Activity
 without Activity
 Both
 Exclude Credit Balance Only Clients
 Select Age of Past Due Clients: 0

Threshold Billing

OK Cancel Load Save

Figure 38, **Options** tab of Generate Statements program

There are three different types of threshold billing:

- You can bill fees, expenses, or advances only when their specified thresholds are met.
- You can bill all fees, expenses, and advances if any threshold is met.
- You can bill all fees, expenses, and advances if the total threshold is met.

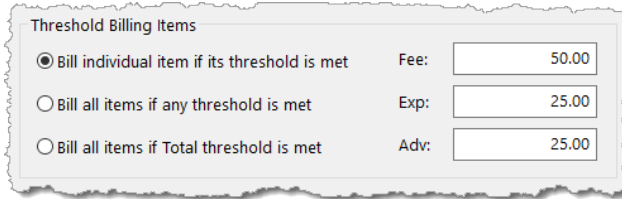

Threshold Billing Items

Bill individual item if its threshold is met Fee:

Bill all items if any threshold is met Exp:

Bill all items if Total threshold is met Adv:

Figure 39, Threshold Billing Options

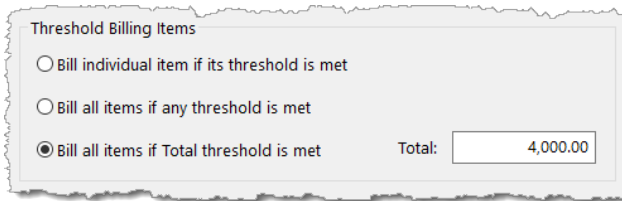

Threshold Billing Items

Bill individual item if its threshold is met

Bill all items if any threshold is met

Bill all items if Total threshold is met Total:

Figure 40, Threshold Billing Options for Total Threshold

If you do not want to use threshold billing, simply leave all threshold amounts shown set at \$0.00.

Threshold Billing Examples

Example	Solution
Bill client when total work-in-process reaches \$500.	Select the Bill all items if Total threshold is met option. Set the client's Total Threshold at 500.00.
Client's expenses not billed until expense work-in-process reaches \$10.	Select the Bill individual item if its threshold is met option. Set the client's Expense Threshold at 10.00.
Work-in-process not billed for any client unless total work-in-process is greater than \$25.00.	When running statements, select the Bill all items if Total threshold is met option. Set the Total Threshold at 25.00.
Bill client's fees when fee threshold of \$300.00 is met and bill client's expenses when expense threshold of \$50.00 is met. Do not bill expenses until the threshold of \$50.00 is met.	Select the Bill individual item if its threshold is met option. Set the client's Fee Threshold at 300.00 and the Expense Threshold at 50.00.
Bill client if fee work-in-process reaches \$100 or advance work-in-process reaches \$30 or expense work-in-process reaches \$30. All fees, expenses and advances will be billed whenever any one of the thresholds is reached.	Select the Bill all items if any threshold is met option. Set the client's Fee Threshold at 100.00, the Expense Threshold at 30.00, and the Advance Threshold at 30.00.

Courtesy Discount

A Courtesy Discount can be given to a client. The discount is calculated at the time the statement is processed. Discounts can be given as a percentage of fees billed or as a specified amount. The discount is given at the time the statement is run and is proportionately deducted from each timekeeper's fee amounts when the statement is updated. Only the **Amount** field is adjusted; the **Hours Worked**, **Hours to Bill**, and **Rate** fields are not adjusted. You can set up clients to receive the discount on each statement processed or receive the discount only once.

The **Billing Options** tab in the Client file is used to set up a client to receive a courtesy discount. There are three fields that are available:

Discount Type This option allows you to specify a percentage-based discount or a specific amount to discount.

Percent/Amount Depending on the Discount Type specified, this field allows you to specify the discount percentage or the discount amount.

Change Discount Type to None after statement updated

This option determines whether a discount is applied once or on every statement for the matter. Select the check box if you only want to apply the discount once. Clear the check box to apply the discount to every future statement for the matter.

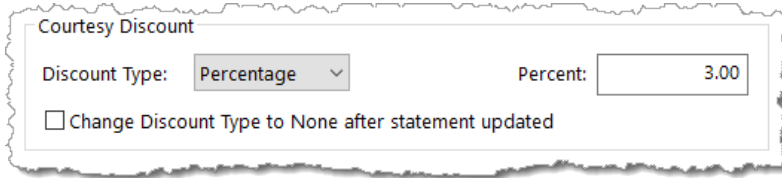

Figure 41, A recurring 3% discount

The amount or percentage being discounted is printed on the Detail Work-In-Process Report, the Summary Work-In-Process Report and the Detail Client List Report. Any courtesy discounts that are billed and updated are treated as write-downs. Courtesy discounts are shown separate from write-downs on the Write-Up/Write-Down Report, Category Productivity Report, and Timekeeper Productivity Report. Courtesy discounts are combined with the fee write-down on the Client Ledger Report and the Client Productivity Report. Courtesy discounts can be shown as a separate column or combined with the net write-up/write-down column on the Client Analysis Report.

You can specify the position of the courtesy discount information on the statement in the **Courtesy Discount Position** field on the **Options** tab of the Statement Customization program (Figure 42).

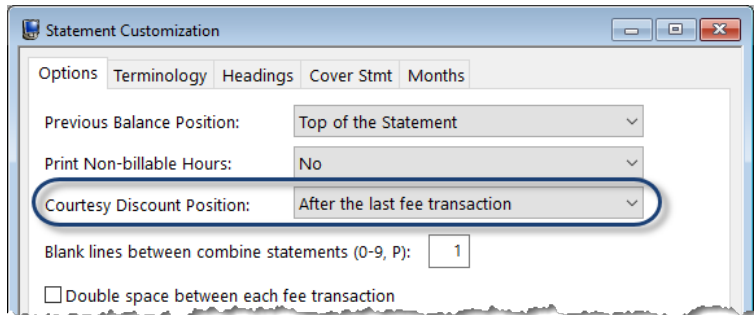

Figure 42, Statement Customization program, **Options** tab

You can specify the following options in the Courtesy Discount Position field:

- After the last fee transaction
- After the current services rendered line
- Just before the balance due

Additionally, you can edit the "Courtesy Discount" terminology on Line 10 of the **Terminology** tab in Statement Customization (Figure 43).

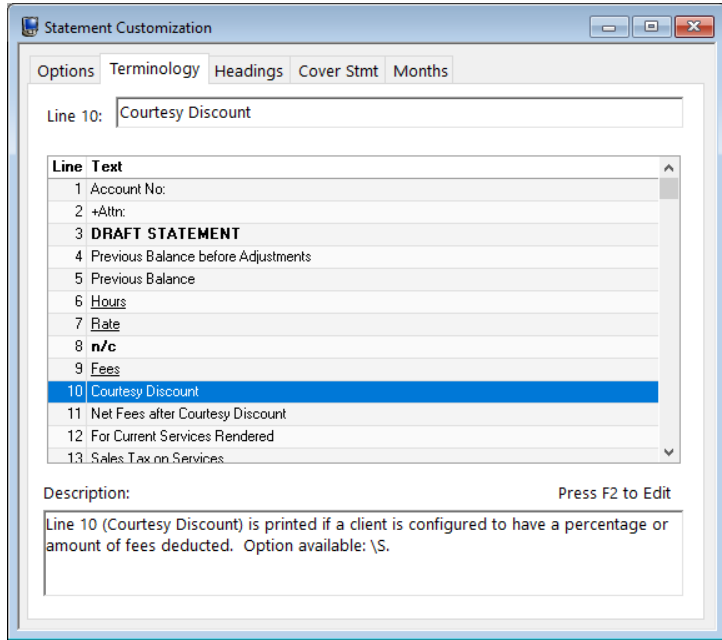

Figure 43, Statement Customization Program, **Terminology** tab

If you use a fee threshold when running statements, the courtesy discount will be included when determining if a statement will be run. Courtesy discounts do not apply to Type 6 transactions for progress billing clients.

The amount of the archived transaction will include the courtesy discount (prorated).

Note: Entering a Courtesy Discount for a client with a previous balance does not affect the previous balance. Courtesy Discounts will only apply toward fees that are being billed on the current statement.

Training Videos



You can view the following training video for more information. Clicking the link will open the training video in your browser. All training videos are also accessible in the software via the **Help | Training Videos** menu and at [Tabs3.com/video](https://www.tabs3.com/video).

 [Using Courtesy Discounts](#)

Resources

Additional information on the features included in this guide is available via Tabs3 Billing's built-in help files, Tabs3 Training Videos, and the Tabs3 Knowledge Base.

Built-in Help

Help is installed with the software and is easily accessed by pressing F1, by clicking the  button, or by selecting the **Help | Help Topics** menu option. Help includes detailed information regarding specific programs. Clicking the  button opens the relevant Help topic for the window you are currently using. Many times, reading the appropriate Help topic may be the fastest way to find your answer.

Knowledge Base

Tabs3 and PracticeMaster publishes an extensive Knowledge Base on the Internet with advanced information. It contains information on Error Troubleshooting, Networking & Windows Issues, "How To" articles, and product-related articles. You can access the Knowledge Base via the software from the **Help | Internet Resources | Knowledge Base** menu option or from your Internet browser at support.Tabs3.com.

- [R11616](#) - All About Tabs3 Split Billing

Training Videos

You can view the following training videos for more information. Clicking a link will open the associated training video in your browser. All training videos are also accessible in the software via the **Help | Training Videos** menu and at Tabs3.com/video.



[How Rates Work](#)



[Contingency Billing](#)



[Flat Fee Billing](#)



[Split Billing](#)



[eBilling Using Tabs3 and Taskbill](#)

Tabs3 Support

Tabs3 Software provides some of the best support in the industry. Service to our customers is extremely important to us—so much so that our motto is:

Reliable software. Trusted service.

Support is provided at no charge with a maintenance plan and is available from 8:00 a.m. to 5:00 p.m. Central Time, Monday through Friday. If you have any questions, please feel free to call our Support staff at (402) 419-2210.

Email support is also available for all firms on maintenance. Our support team responds to emails during office hours. Our goal is to respond to your question within one business day. Please keep in mind that time-sensitive and complex issues are better handled over the phone. To request email support, visit [**Tabs3.com/support**](https://www.tabs3.com/support).

Index

A		Contingency Billing	15
Adjust Flat Fee Clients	19	configuring	15
		definition	15
		end of matter procedures	16
		generating statements	16
		questions to ask	15
		training video	17
B		Costs	
Billing Adjustments Guide	2	training video	3
Billing Cycle	2	Courtesy Discount	
data entry	2	training video	55
distributing statements	3	Courtesy Discount	53
generating final statements	3	configuring	53
generating pre-bills	2	definition	53
making adjustments	2	example	54
overview	2	position on statements	54
reviewing pre-bills	2	terminology used	55
updating statements	3		
Billing Methods		D	
contingency billing	4	Default Billing Rate	12
courtesy discount	5	Determining Rates	
flat fee billing	4	how Tab3 selects the default billing	
hourly billing	4	rate	12
overview	3	via client's hourly rate	12
progress billing	4	via Fee Rate Table	6
retainer billing	4	via timekeeper level	7
split billing	4	via timekeeper rates	10
task based billing	4		
threshold billing	4	F	
value billing	4	Fee Rate Table	
Billing Rate Code		example	6
definition	11	Fees	
example	11	billing rate methods table	5
		calculation of amount to be billed	5
		hours tracked	5
		training video	3
		Flat Fee Billing	17
		configuring	17
C			
Client Funds			
and retainer billing	30		
Client Hourly Rate	12		

definition17
 implementing 17
 questions to ask 17
 training video20

G

Guides 1

H

Help56
 Hourly Billing 5
 client hourly rate method 12
 fee rate table method 6
 how Tabs3 selects the default billing rate 12
 Rate Code 0 and default billing rate12
 timekeeper level method 7
 timekeeper rates method 10
 training video14

K

Knowledge Base1, 56

M

Monthly Retainer34, 36

N

Nonrefundable Retainer32-34, 37

P

Payments
 and retainer billing31
 Phases for Task Based Billing 46
 Professional Discount
 See Courtesy Discount
 Progress Billing22
 and retainers 29
 configuration 23
 definition22
 implementing 23
 procedure23
 questions to ask22
 reconciliation statement24
 reconciliation statement example25

R

Rate Table 6
 Rates for Hourly Billing 5
 Recurring Retainer36
 Refundable Retainer 33
 Replenishable Retainer35
 Reports
 task based billing reports49
 Resources56
 Help 56
 Knowledge Base 56
 Tabs3 Support57
 training videos56
 Retainer Billing26
 and client funds30
 client funds example30
 entering payments31
 examples31
 method comparisons31
 methods 26
 progress billing example29
 questions to ask26
 TAS integration example28
 types26
 using Tabs3 Trust Accounting 26

Retainers
 and progress billing29

questions to ask 51
 Timekeeper Level Rates 7
 Timekeeper Rates 10
 Training Videos56
 Trust Accounting Software 26

S

Split Billing39
 configuring40
 configuring main client40
 definition39
 procedure40
 questions to ask39
 reversing a split43
 Split Billing Matter example42
 Split Billing tab in Client file40
 Split Options example40
 training video43
 Statements
 training video 3
 Support57

U

Undo Split Billing43

V

Value Billing20
 configuration21
 definition20
 implementing21
 transaction codes21
 Videos56
 courtesy discount55
 flat fee billing20
 hourly billing14
 split billing43
 task based billing50

T

Tabs3 Support57
 Task Based Billing44
 activity definition45
 associating categories with task code
 sets48
 defining activity and expense codes47
 defining task code sets45
 defining tasks and phases46
 definition44
 task code set example44
 enabling for clients48
 expense definition45
 phase definition44
 setting up in Tabs345
 task definition44
 training video50
 Tasks for Task Based Billing46
 Threshold Billing50
 definition50
 examples53

W

Web Site 1